







Seco

535-560W

High efficiency monofacial modules

PERC 182mm

• PERC MODULE ADVANTAGE

-  Less mismatch to get more power
-  Less power loss by minimizing the shading impact
-  Excellent low-light performance
-  Low BOS and LCOE
-  3 times EL test to ensure best quality
-  Superior load capacity
2400 Pa wind load & 5400 Pa snow load

• QUALITY SYSTEM

ISO9001 / ISO14001 / ISO45001

• PRODUCT CERTIFICATION



• INSURANCE

PICC

• WARRANTY

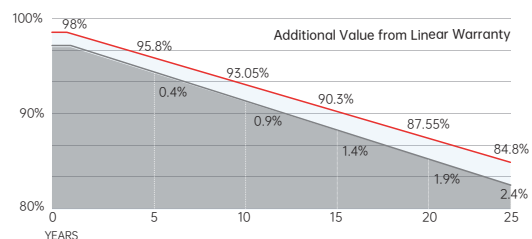

15 YEARS Guarantee on product material and workmanship

25 YEARS Linear power output warranty



SERAPHIM ENERGY GROUP CO., LTD.

Add: NO.18, Shichuan Road, Jinzhai Economic Development Zone, Lu'an City, Anhui Province
 Tel: +86-564-7736177 Email: info@seraphim-energy.com

Mechanical Specifications

External Dimension	2278 x 1134 x 35 mm
Weight	27.0 kg
Solar Cells	PERC Mono(144 pcs)
Front / Back Glass	3.2mm AR coating tempered glass, low iron
Frame	Anodized aluminium alloy
Junction Box	IP68, 3 diodes
Output Cables	4.0mm ² , 250mm(+)/350mm(-) or Customized Length

Technical drawing

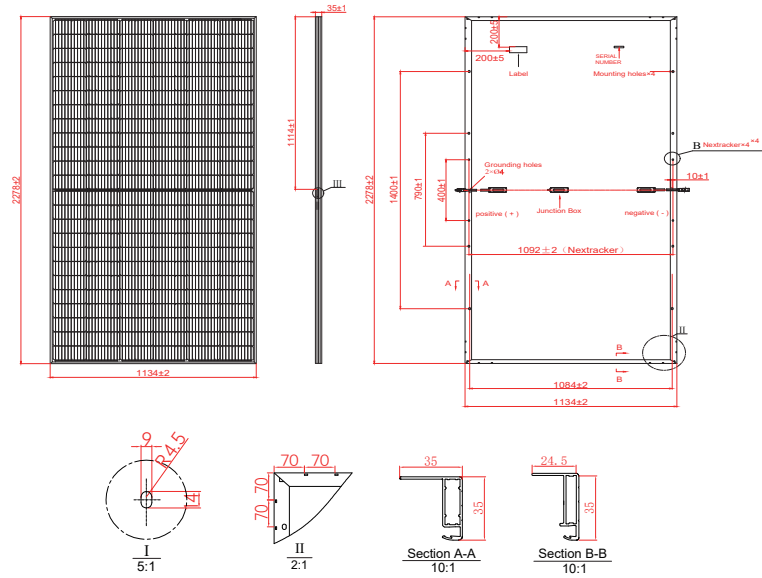

Packing Configuration

Container	20'GP	40'HQ
Pieces per Pallet	31	31
Pallets per Container	4	20
Pieces per Container	124	620

For details, please consult SERAPHIM.

Electrical Characteristics

Module Type	SRP-535-BMA-HV		SRP-540-BMA-HV		SRP-545-BMA-HV		SRP-550-BMA-HV		SRP-555-BMA-HV		SRP-560-BMA-HV	
	STC	NOCT	STC	NOCT	STC	NOCT	STC	NOCT	STC	NOCT	STC	NOCT
Maximum Power -P _{mp} (W)	535	402	540	406	545	409	550	414	555	418	560	422
Open Circuit Voltage -V _{oc} (V)	49.40	46.08	49.50	46.18	49.60	46.32	49.70	46.40	49.80	46.50	49.90	46.63
Short Circuit Current -I _{sc} (A)	13.70	11.08	13.81	11.16	13.90	11.23	14.00	11.32	14.10	11.41	14.21	11.48
Maximum Power Voltage -V _{mp} (V)	41.29	38.15	41.55	38.39	41.80	38.41	42.05	38.58	42.31	38.68	42.56	38.83
Maximum Power Current -I _{mp} (A)	12.96	10.52	13.00	10.59	13.04	10.65	13.08	10.73	13.12	10.81	13.16	10.87
Module Efficiency STC-η _m (%)	20.71		20.90		21.10		21.29		21.48		21.68	
Power Tolerance (W)	(0, +4.99)											

STC: Irradiance 1000 W/m² module temperature 25°C AM=1.5 Power measurement tolerance: +/-3%; Voltage measurement tolerance: +/-3%; Current measurement tolerance: +/-4%
NOCT: Irradiance 800 W/m² ambient temperature 20°C wind speed :1m/s Power measurement tolerance: +/-3%; Voltage measurement tolerance: +/-3%; Current measurement tolerance: +/-4%

Temperature Ratings

P _{max} Temperature Coefficient	-0.34 %/°C
V _{oc} Temperature Coefficient	-0.26 %/°C
I _{sc} Temperature Coefficient	+0.05 %/°C

Application Conditions

Maximum System Voltage	1500V DC
Maximum Series Fuse Rating	25 A
Operating Temperature	-40~+85 °C
Nominal Operating Cell Temperature	45±2 °C
Mechanical Load	Front side 5400 Pa / Back side 2400 Pa

I-V Curve

