









# Nebula 430-445w

Lightweight high efficiency modules



**TOPCon 182mm**

• **TOPCon MODULE ADVANTAGE**

-  Multi-Busbar technology
-  Superior load capacity
-  High module efficiency
-  Excellent low-light performance
-  Lower annual attenuation  
Longer warranty
-  Low BOS and LCOE
-  Reduce hot spot effect
-  Higher bifaciality

• **QUALITY SYSTEM**

ISO9001 / ISO14001 / ISO45001

• **PRODUCT CERTIFICATION**



• **INSURANCE**

**PICC**

• **WARRANTY**

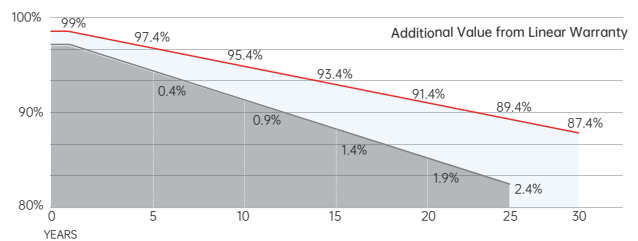

**15 YEARS** Guarantee on product material and workmanship

**30 YEARS** Linear power output warranty



**SERAPHIM ENERGY GROUP CO., LTD.**

Add: NO.18, Shichuan Road, Jinzhai Economic Development Zone, Lu'an City, Anhui Province  
Tel: +86-564-7736177 Email: info@seraphim-energy.com

## Electrical Characteristics

Module Type	SRP-430-BTD-HV		SRP-435-BTD-HV		SRP-440-BTD-HV		SRP-445-BTD-HV	
	STC	NOCT	STC	NOCT	STC	NOCT	STC	NOCT
Maximum Power at STC (Pmp)	430	324	435	328	440	332	445	336
Open Circuit Voltage (Voc)	38.90	36.96	39.10	37.15	39.30	37.34	39.50	37.53
Short Circuit Current (Isc)	13.99	11.19	14.07	11.26	14.15	11.32	14.23	11.38
Maximum Power Voltage (Vmp)	32.30	30.41	32.50	30.62	32.70	30.82	32.90	31.02
Maximum Power Current (Imp)	13.32	10.66	13.39	10.71	13.47	10.77	13.54	10.83
Module Efficiency at STC(ηm)	22.02		22.28		22.53		22.79	
Power Tolerance(W)	(0, +4.99)							
Maximum System Voltage	1500V DC							
Maximum Series Fuse Rating	25 A							

STC: Irradiance 1000 W/m<sup>2</sup> module temperature 25°C AM=1.5  
Power measurement tolerance: +/-3%

## Temperature Characteristics

Pmax Temperature Coefficient	-0.29 %/°C
Voc Temperature Coefficient	-0.25 %/°C
Isc Temperature Coefficient	+0.046 %/°C
Operating Temperature	-40 ~ +85 °C
Nominal Operating Cell Temperature(NOCT)	45±2 °C

## Mechanical Specifications

External Dimensions	1722 x 1134 x 28 mm
Weight	21.0 kg
Solar Cells	TOPCon 182 x 91mm (108 pcs)
Front Glass	3.2mm AR coating tempered glass, low iron
Frame	Anodized aluminium alloy
Junction Box	IP68, 3 diodes
Output Cables	4.0mm <sup>2</sup> , 250mm(+)/350mm(-) or Customized Length
Mechanical Load	Front side 5400Pa/ Rear side 2400Pa

## Packing Configuration

	1722 x 1134 x 28 mm	
Container	20'GP	40'HQ
Pieces per Pallet	39	39
Pallets per Container	6	26
Pieces per Container	234	1014

For details, please consult SERAPHIM.

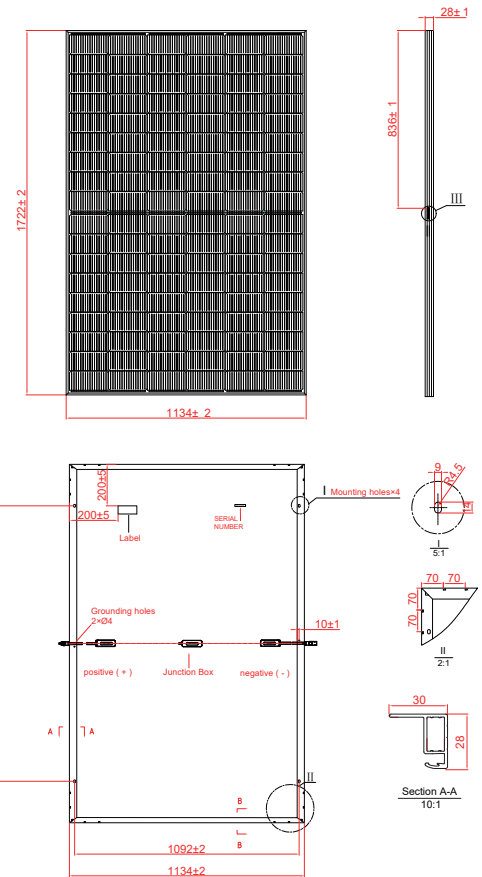

## I-V Curve

